

NO.	REVISIONS	DATE	DEVISER
1.			
2.			
3.			

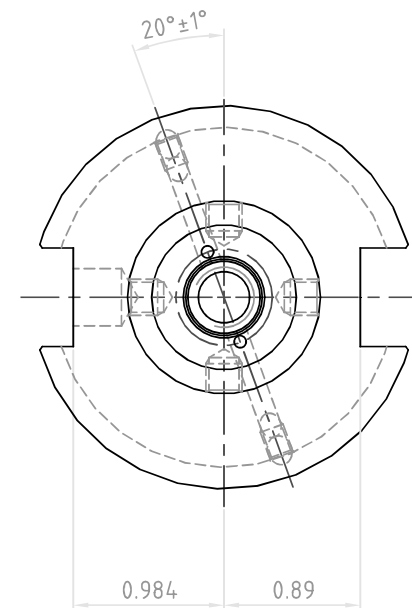
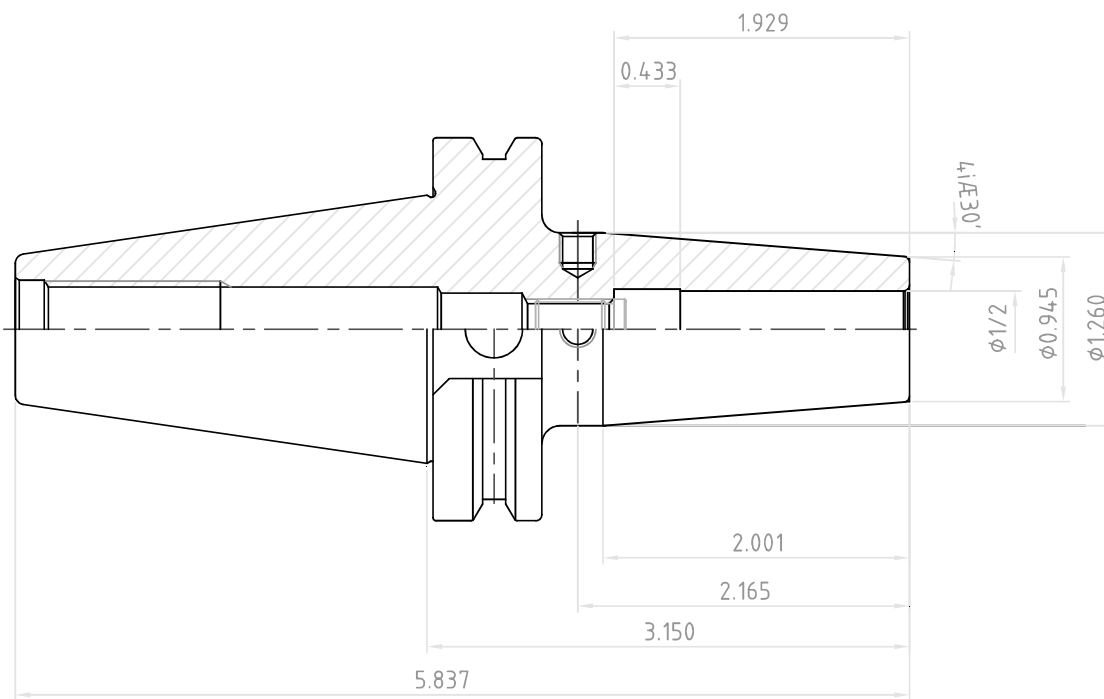
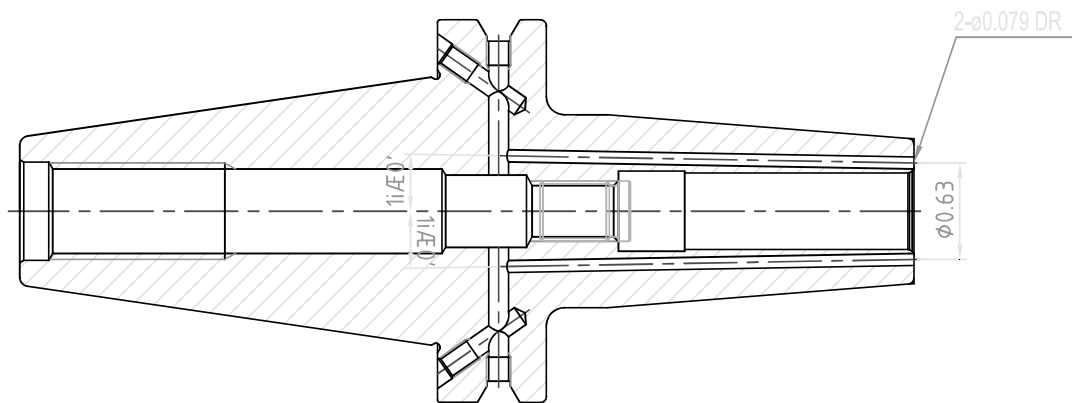

 YG-1 CO., LTD.	SSK CONTROL NUMBER		
	CCT40AD/B-SFH1/2(12.700)C-3.150(80)		
	EDP No.	VB032J	SCALE 1 : 1