

NO.	REVISIONS	DATE	DEVISER
1.			
2.			
3.			

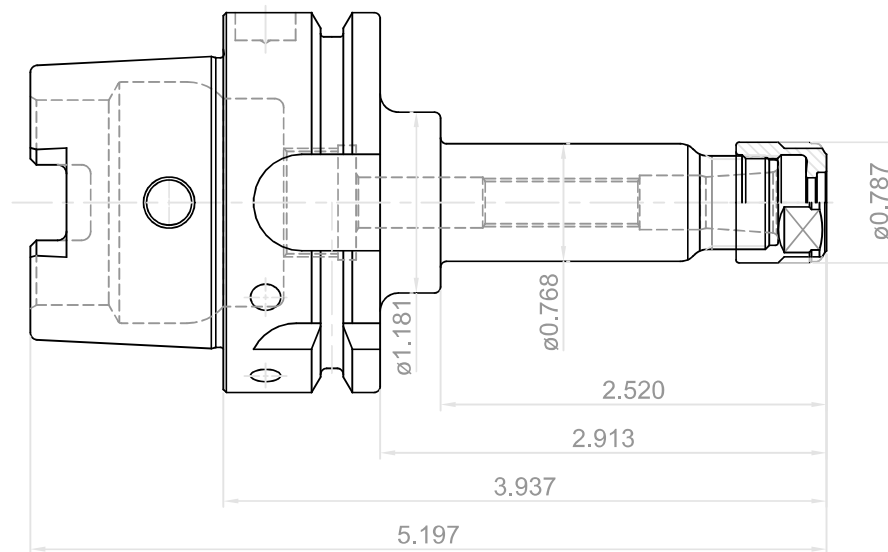

 YG-1 CO., LTD.	DESCRIPTION	
	HSK63A-SKA06-3.94(100)	
EDP No.	TQ100	SCALE 1 : 1