

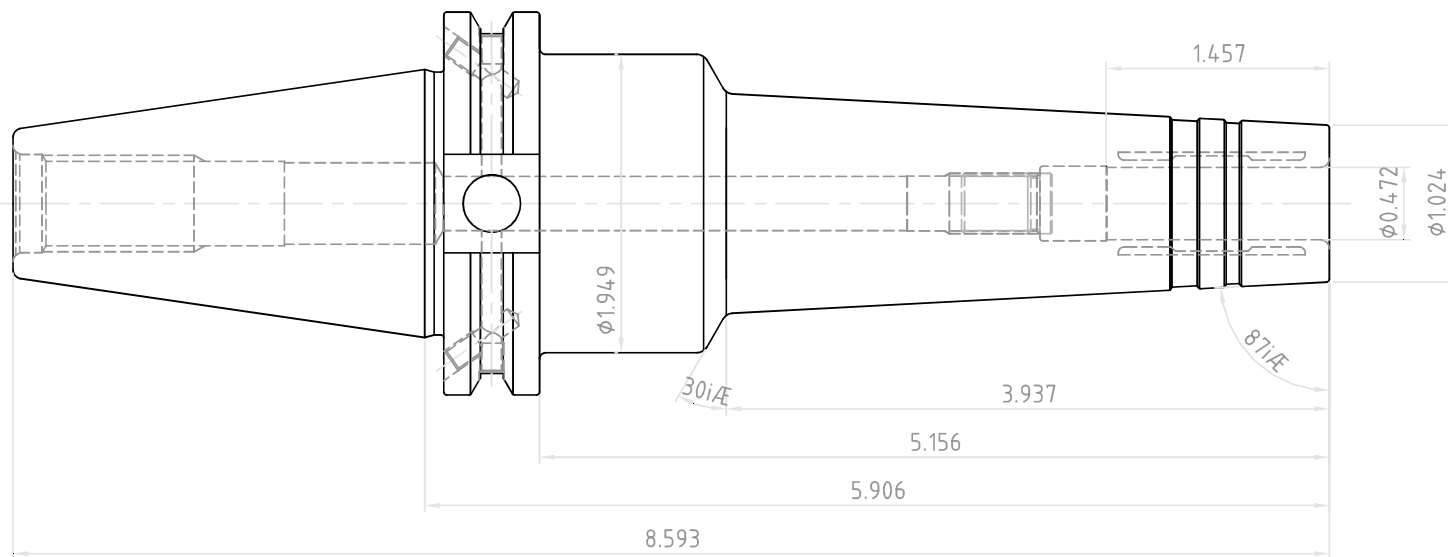

NO.	REVISIONS	DATE	DEVISER
1.			
2.			
3.			



 YG-1 CO., LTD.	DESCRIPTION		
	CAT40AD/B-HMC0.47(12)-5.91(150)		
	EDP No.	WK114HMC	SCALE 1 : 1