

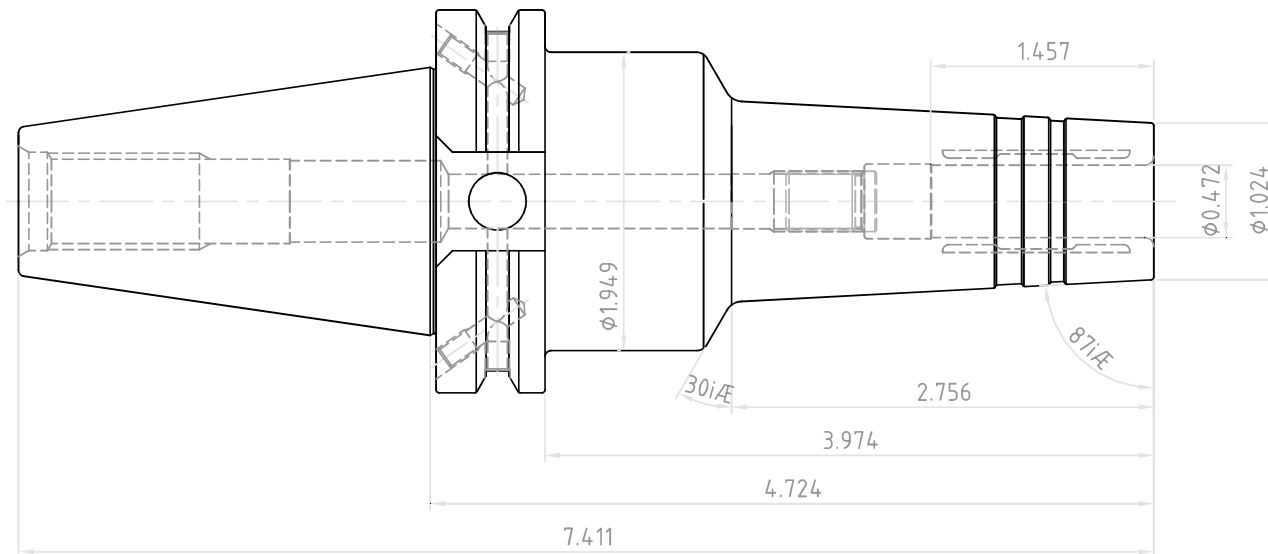

NO.	REVISIONS	DATE	DEVISER
1.			
2.			
3.			



 YG-1 CO., LTD.	DESCRIPTION		
	CCT40AD/B-HMC0.47(12)-4.72(120)		
EDP No.	WB112HMC	SCALE	1 : 1